

Features

- Universal input 85-265VAC
- High Efficiency Rating up to 94%
- Operating ambient temperature range: -40°C to +85
- Approved to UKCA, CE, CB, cURus, FCC, RoHS & REACH
- EN/IEC/UL 62368-1 Safety Approved
- Output Voltage 12 - 53VDC



Ideal Power's 43TEH450-USxy 450W Enclosed AC/DC Power Supply (PSU) Series are certified to UKCA, CE, cURus, FCC, CB, RoHS, REACH & EN 62368-1/IEC 62368-1/UL 62368-1 Standards and comply with the relevant Efficiency Regulations. These are primarily used in ITE, Audio & Video Industries and customised solutions are available upon request.

Part Number Structure

Series Name	Output Power (W)	Input Voltage (V AC)	Output Quantity	Output Voltage (V DC)	Protection Type	Fan Options	Conformal Coating Options
43TAH & 43TEH	- 450	U	S	12	□	- F2	□
A: Open type E: Enclosed type		U: Universal 85 ~ 264	S: Single	12: 12 15: 15 24: 24 28: 28 36: 36 48: 48 53: 53	□: CLASS I B: CLASS II	□: Fan connector with fixed fan speed control Y: Fan connector with variable fan speed control For TEH450 only: Fixed fan speed F1: Fan 1, fan on the top F2: Fan 2, fan on the side Variable speed fan Y1: Fan 1, fan on the top Y2: Fan 2, fan on the side	□: None R: Conformal Coating

Models

Model Number	Output Voltage V DC	Output current				Input Power @ No Load W	Efficiency %	Maximum Capacitor Load µF
		Natural Convection A	Conduction Cooling A	Forced Air Cooling				
				21 CFM External Fan A	Internal Fan A			
43TAH450US12(-Y)	12	20.8	23.3	37.5	---	0.3	91	31250
43TEH450US12(-Y)	12	20.8	23.3	37.5	---	0.3	91	31250
43TEH450US12-F1(Y1)	12	---	---	---	37.5	0.4	91	31250
43TEH450US12-F2(Y2)	12	---	---	---	37.5	0.4	91	31250
43TAH450US15(-Y)	15	16.6	18.6	30.0	---	0.5	92	20000
43TEH450US15(-Y)	15	16.6	18.6	30.0	---	0.5	92	20000
43TEH450US15-F1(Y1)	15	---	---	---	30.0	0.8	92	20000
43TEH450US15-F2(Y2)	15	---	---	---	30.0	0.8	92	20000
43TAH450US24(-Y)	24	13.3	14.55	18.75	---	0.5	93	7820
43TEH450US24(-Y)	24	13.3	14.55	18.75	---	0.5	93	7820
43TEH450US24-F1(Y1)	24	---	---	---	18.75	0.8	93	7820
43TEH450US24-F2(Y2)	24	---	---	---	18.75	0.8	93	7820
43TAH450US28(-Y)	28	11.4	12.5	16.1	---	0.5	93	5750
43TEH450US28(-Y)	28	11.4	12.5	16.1	---	0.5	93	5750
43TEH450US28-F1(Y1)	28	---	---	---	16.1	0.8	93	5750
43TEH450US28-F2(Y2)	28	---	---	---	16.1	0.8	93	5750
43TAH450US36(-Y)	36	8.9	9.72	12.5	---	0.5	93	3500
43TEH450US36(-Y)	36	8.9	9.72	12.5	---	0.5	93	3500
43TEH450US36-F1(Y1)	36	---	---	---	12.5	0.8	93	3500
43TEH450US36-F2(Y2)	36	---	---	---	12.5	0.8	93	3500
43TAH450US48(-Y)	48	6.65	7.3	9.4	---	0.5	94	1960
43TEH450US48(-Y)	48	6.65	7.3	9.4	---	0.5	94	1960
43TEH450US48-F1(Y1)	48	---	---	---	9.4	0.8	94	1960
43TEH450US48-F2(Y2)	48	---	---	---	9.4	0.8	94	1960
43TAH450US53(-Y)	53	6.05	6.6	8.55	---	0.5	94	1600
43TEH450US53(-Y)	53	6.05	6.6	8.55	---	0.5	94	1600
43TEH450US53-F1(Y1)	53	---	---	---	8.55	0.8	94	1600
43TEH450US53-F2(Y2)	53	---	---	---	8.55	0.8	94	1600

Input Specifications

Parameter	Conditions	Min	Typ	Max	Unit
Operating input voltage range	AC input	85	--	267	VAC
	DC input	120	--	370	VDC
Input frequency	AC input	47	--	63	Hz
Input current	100VAC and Full Load	--	--	5.8	A
	240VAC and Full Load	--	--	2.4	
No load input power	230VAC	43TAH(-Y), 43TEH(-Y)	0.3	--	Watts
		Others	0.5	--	
	230VAC	43TEH -F□(Y□)	0.5	--	
		Others	0.8	--	
Leakage current	264VAC	--	--	300	µA
Power Factor		0.95	--	--	
Startup time		--	--	2000	ms
Rise time		--	30	--	ms
Hold up time	115VAC and Full Load	--	14	--	ms
Input inrush current	230VAC	--	--	100	A
Input protection	Internal fuse in line and neutral				T6.3A/250VAC

Input Specifications (continued)

Main output remote control	Positive Logic	Main power ON	Open or 3 ~ 12 VDC			
	Referenced to “-Control”	Main power OFF	Short or 0 ~ 1.2VDC			
	*Standby power always present	Input current of Control	-0.5	--	1	mA

Output Specifications

Parameter	Conditions	Min	Typ	Max	Unit	
Output power	Forced air cooling	All	--	--	450	W
	Conduction cooling @ 230VAC	12Vout, 15Vout	--	--	280	
		Others	--	--	350	
	Natural convection @ 230VAC	12Vout, 15Vout	--	--	250	
		Others	--	--	320	
*Please refer to the derating curve for detailed rating.						
Initial set voltage accuracy	230V AC and Full Load	-1.0	--	+1.0		
Line regulation	Low Line to High Line at Full Load	-0.2	--	+0.2		
Load regulation	No Load to Full Load	-0.5	--	+0.5	%	
	10% Load to 90% Load	-0.4	--	+0.4		
Voltage adjustability	Maximum output deviation is inclusive of remote sense	-8	--	+8		
Minimum load		--	0	--		
Ripple and noise	Measured by 20MHz bandwidth		--	--		
	With a 1µF/25V 1206 X7R MLCC	12Vout	--	250	--	mVp-p
		15Vout	--	300	--	
	With a 1µF/50V 1206 X7R MLCC	24Vout	--	240	--	
		28Vout	--	280	--	
		36Vout	--	360	--	
		48Vout	--	480	--	
With a 0.1µF/100V 1206 X7R MLCC	53Vout	--	530	--		
Temperature coefficient		-0.02	--	+0.02	%/°C	
Transient response	Load step from 50 ~ 75% change at 2.5A/µs	Peak deviation	--	3	--	% Vout
		Recovery time	--	600	--	µs
Over voltage protection	% of Vout(nom); Latch mode	100	--	135	%	
Over load protection	% of maximum lout rated; Hiccup mode	115	--	155		
Short circuit protection	Protection level 1 (nominal)	Continuous, automatic recovery				
	Protection level 2 (instantaneous high current)	Latch				
Standby power supply	Always present when AC supplied	5V / 2000mA				
Fan power supply	Fixed fan speed function	12V / 500mA				
Main output Power Good signal	Referenced to “GND”	Power good	Low			
		Power off	Open collector			

General Specifications

Parameter	Conditions		Min	Typ	Max	Unit
Isolation voltage	1 minute (Reinforced insulation)	Input to Output	3000	--	--	V AC
		Input (Output) to F.G	2000	--	--	
Isolation resistance	500V DC		0.1	--	--	GΩ
Switching frequency	230VAC, Full load	15Vout	--	75	--	kHz
		Others	--	65	--	
Safety approvals	IEC/ EN/ UL 62368-1				UL:E193009 CB:UL(Demko)	
Weight	43TAH(-Y)					462g(16.29oz)
	43TEH(-Y)					504g(17.77oz)
	43TEH -F1(Y1)					524g(18.48oz)
	43TEH -F2(Y2)					552g(19.47oz)
MTBF	MIL-HDBK-217F Ta=25°C, Full load				4.093 x 10 ⁵ hrs	

Environmental Specifications

Parameter	Conditions		Min	Typ	Max	Unit
Operating ambient temperature	With derating	43TAH(-Y), 43TEH(-Y)	-40	--	+85	°C
		43TEH -F□(Y□)	-40	--	+80	
Storage temperature range	43TAH(-Y), 43TEH(-Y)		-40	--	+85	°C
	43TEH -F□(Y□)		-40	--	+80	
Over temperature protection	Internal thermistor; Latch mode		110	--	125	
Operating altitude	With derating		--	--	5000	m
Shock						IEC60068-2-27
Vibration						IEC60068-2-6
Relative humidity	Non-condensing					5% to 95% RH

EMC Specifications

Parameter	Conditions		Level	
EMI	EN55032 and FCC Part 15		Conducted	Class B
	For optimum EMI performance, the power supply should be mounted to a metalplate grounded to all 4 mounting holes of the power supply. To comply with safety standards, this plate must be properly grounded to protective earth.		Radiated	Class A
Harmonic currents	EN61000-3-2	Full Load		
Voltage flicker	EN61000-3-3			
EMS	EN55024			
ESD	EN61000-4-2		Perf. Criteria A	
Radiated immunity	EN61000-4-3	3 V/m	Perf. Criteria A	
Fast transient	EN61000-4-4	± 2kV	Perf. Criteria A	
Surge	EN61000-4-5	DM ± 1kV and CM ± 2kV	Perf. Criteria A	
Conducted immunity	EN61000-4-6	20 Vr.m.s	Perf. Criteria A	
Power frequency magnetic field	EN61000-4-8	30 A/m		
Dip and interruptions	EN61000-4-11			

Characteristic Curve

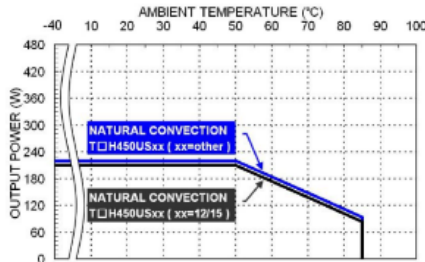

Derating Curve vs. Ambient Temperature
Vin=115VAC and Natural convection

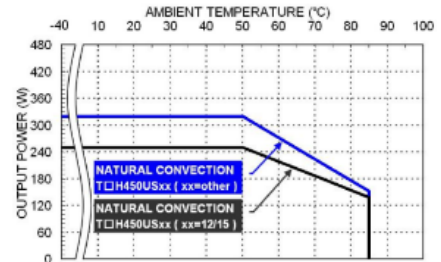

Derating Curve vs. Ambient Temperature
Vin=230VAC and Natural convection

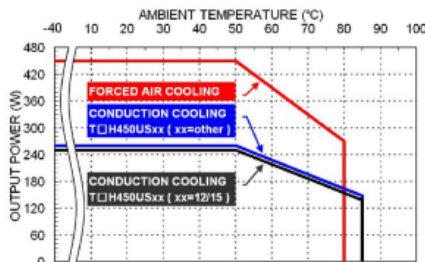

Derating Curve vs. Ambient Temperature
Vin=115VAC and Conduction cooling tested by 43x24.8x0.12cm plate
Forced air cooling with 21CFM (External Fan)

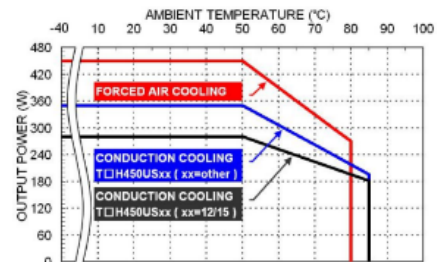

Derating Curve vs. Ambient Temperature
Vin=230VAC and Conduction cooling tested by 43x24.8x0.12cm
Forced air cooling with 21CFM (External Fan)

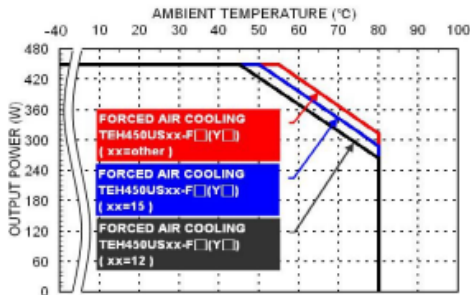

Derating Curve vs. Ambient Temperature
Vin=115VAC and Forced air cooling (Internal Fan)

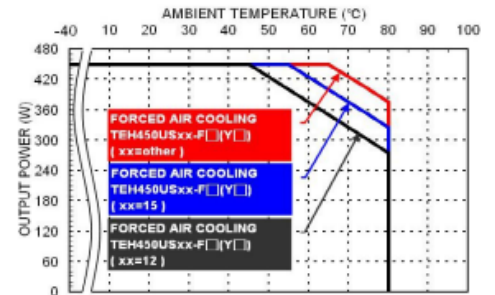

Derating Curve vs. Ambient Temperature
Vin=230VAC and Forced air cooling (Internal Fan)

AC - DC

Characteristic Curve (continued)

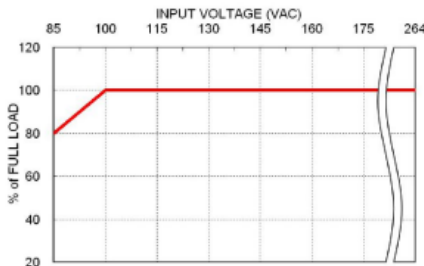

Derating Curve vs. Input Voltage
43T□H450

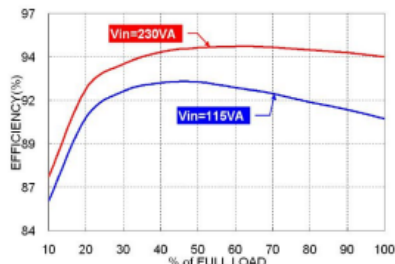

Efficiency vs. Output Load
43T□H450US24 with Forced air cooling

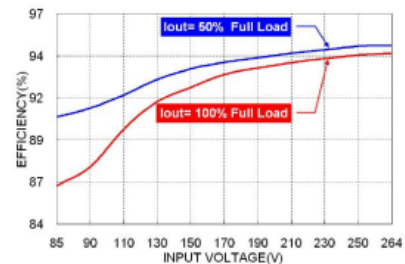

Efficiency vs. Input Voltage
43T□H450US24 with Forced air cooling

Output Sensing

Output sensing function can be applied via connecting wires on CON3. Initially, Pin 7 and Pin 8 are shorted by a jumper set as default, shown as Fig 1.

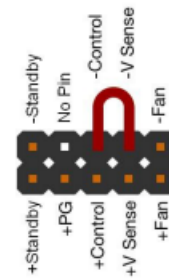
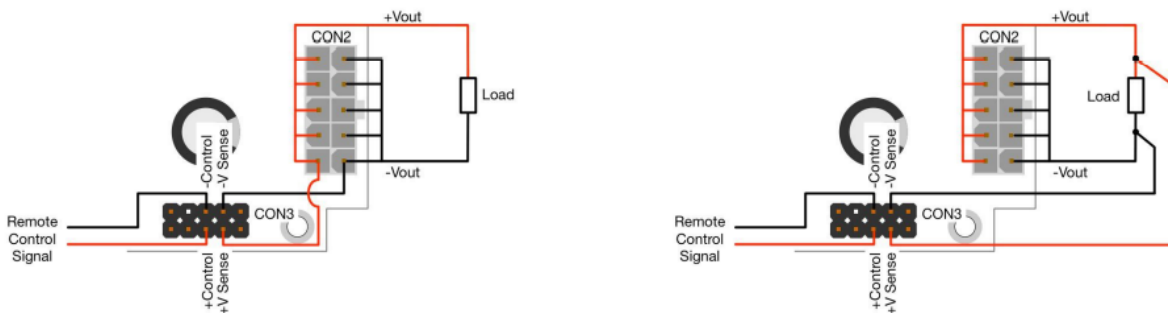

Fig. 1 Default connection

But if remote control function is to be used, the jumper on Pin 7 and Pin 8 should be removed. Since sense pins should not be left open for module stability, please follow the connections as below (Fig. 2).



(a) Sense pins connect to corresponding polarity of Vout pin (b) Sense pins connect to corresponding polarity terminal of load.

Fig. 2 Recommended output sensing connections

Mechanical Drawing

43TAH450USXX (-Y)

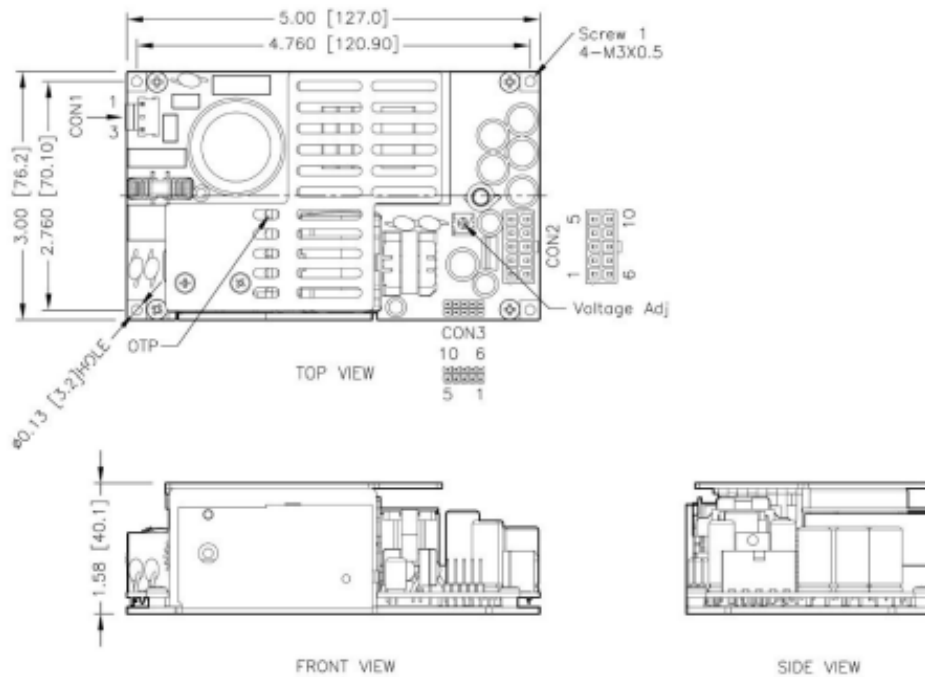

*Either one of four screw holes can be considered as PE connection for CLASS I application.

1. All dimensions in inch [mm]
2. Tolerance : $x.xx \pm 0.02$ [$x.x \pm 0.5$]
 $x.xxx \pm 0.01$ [$x.xx \pm 0.25$]
3. Screw 1 locked torque : MAX 5.2Kgf-cm/0.51N.m

CON1-Input Connector		CON2-Output Connector		CON3 – Aux Connector			
Pin 1	Line	Pin 1,2,3,4,5	+Vout	Pin 1	+Fan	Pin 6	-Fan (GND)
Pin 3	Neutral	Pin 6,7,8,9,10	-Vout	Pin 2	+V Sense	Pin 7	-V Sense
Mates with:		Mates with:		Pin 3	+Control	Pin 8	-Control (GND)
Molex housing: 09-50-8031		Molex housing: 39-01-2105		Pin 4	+PG	Pin 9	No Pin
Molex crimp terminals: 2478,6838,45570		Molex crimp terminals: 5556,45750		Pin 5	+Standby	Pin10	-Standby (GND)

Mates with:

Molex housing: 90143-0008

Molex crimp terminals: 90119

Mechanical Drawing

43TEH450USXX (-Y)

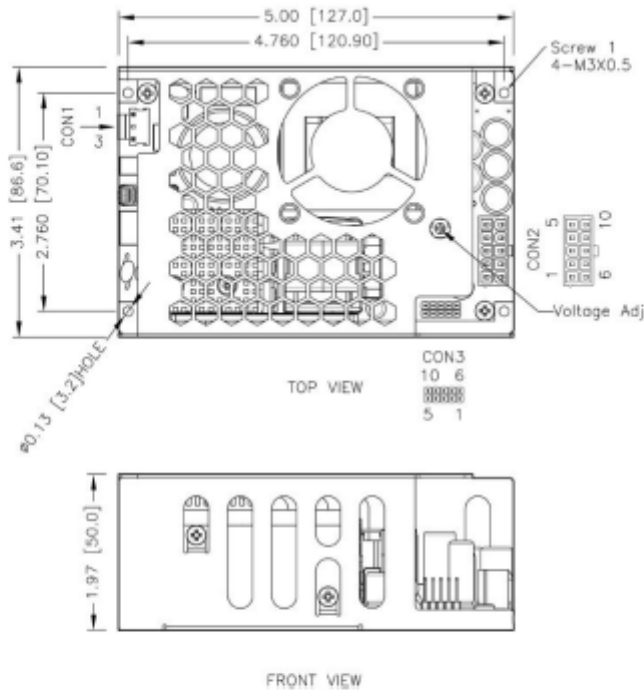

*Either one of four screw holes can be considered as PE connection for CLASS I application.

1. All dimensions in inch [mm]
2. Tolerance : x.xx±0.02 [x.x±0.5]
x.xxx±0.01 [x.xx±0.25]
3. Screw 1 locked torque : MAX 5.2Kgf-cm/0.51N.m

CON1-Input Connector		CON2-Output Connector		CON3 – Aux Connector			
Pin 1	Line	Pin 1,2,3,4,5	+Vout	Pin 1	+Fan	Pin 6	-Fan (GND)
Pin 3	Neutral	Pin 6,7,8,9,10	-Vout	Pin 2	+V Sense	Pin 7	-V Sense
				Pin 3	+Control	Pin 8	-Control (GND)
				Pin 4	+PG	Pin 9	No Pin
				Pin 5	+Standby	Pin10	-Standby (GND)

Mates with:

 Molex housing:
09-50-8031

 Molex crimp terminals:
2478,6838,45570

Mates with:

 Molex housing:
39-01-2105

 Molex crimp terminals:
5556,45750

Mates with:

Molex housing: 90143-0008

Molex crimp terminals: 90119

Mechanical Drawing

43TEH450USXX-F1 (-Y1)

FAN dimension: 50x50x10mm Air flow: 11.4 CFM
The fan's life is shorter than power supply and has only 2 years warranty.

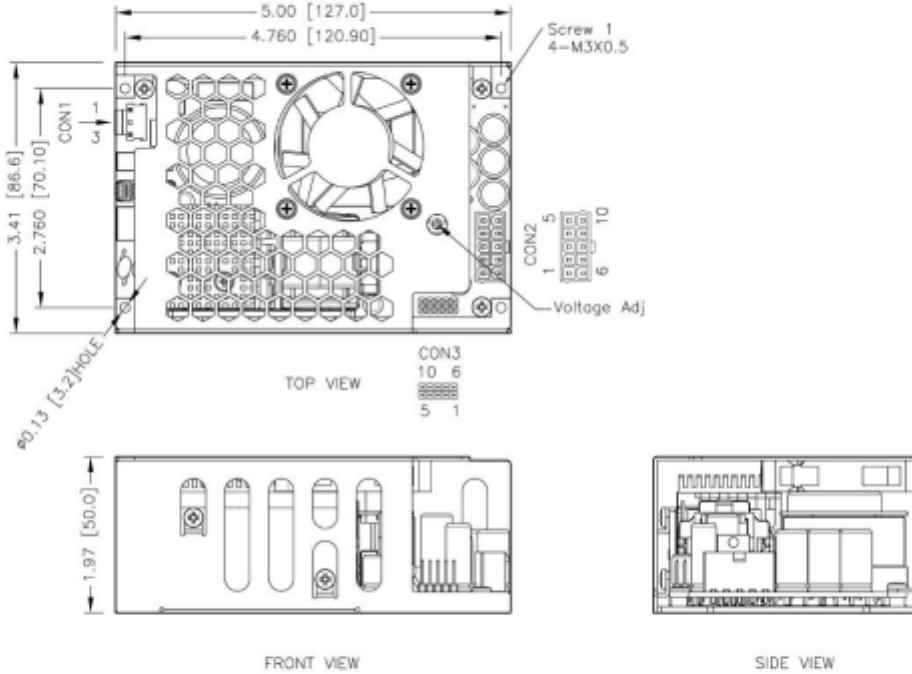

*Either one of four screw holes can be considered as PE connection for CLASS I application.

- All dimensions in inch [mm]
- Tolerance : x.xx±0.02 [x.x±0.5]
x.xxx±0.01 [x.xx±0.25]
- Screw 1 locked torque : MAX 5.2Kqf-cm/0.51N.m

CON1-Input Connector		CON2-Output Connector		CON3 – Aux Connector			
Pin 1	Line	Pin 1,2,3,4,5	+Vout	Pin 1	+Fan	Pin 6	-Fan (GND)
Pin 3	Neutral	Pin 6,7,8,9,10	-Vout	Pin 2	+V Sense	Pin 7	-V Sense
Mates with:		Mates with:		Pin 3	+Control	Pin 8	-Control (GND)
Molex housing: 09-50-8031		Molex housing: 39-01-2105		Pin 4	+PG	Pin 9	No Pin
Molex crimp terminals: 2478,6838,45570		Molex crimp terminals: 5556,45750		Pin 5	+Standby	Pin10	-Standby (GND)
				Mates with:			
				Molex housing: 90143-0008			
				Molex crimp terminals: 90119			

Mechanical Drawing

43TEH450USXX-F2 (-Y2)

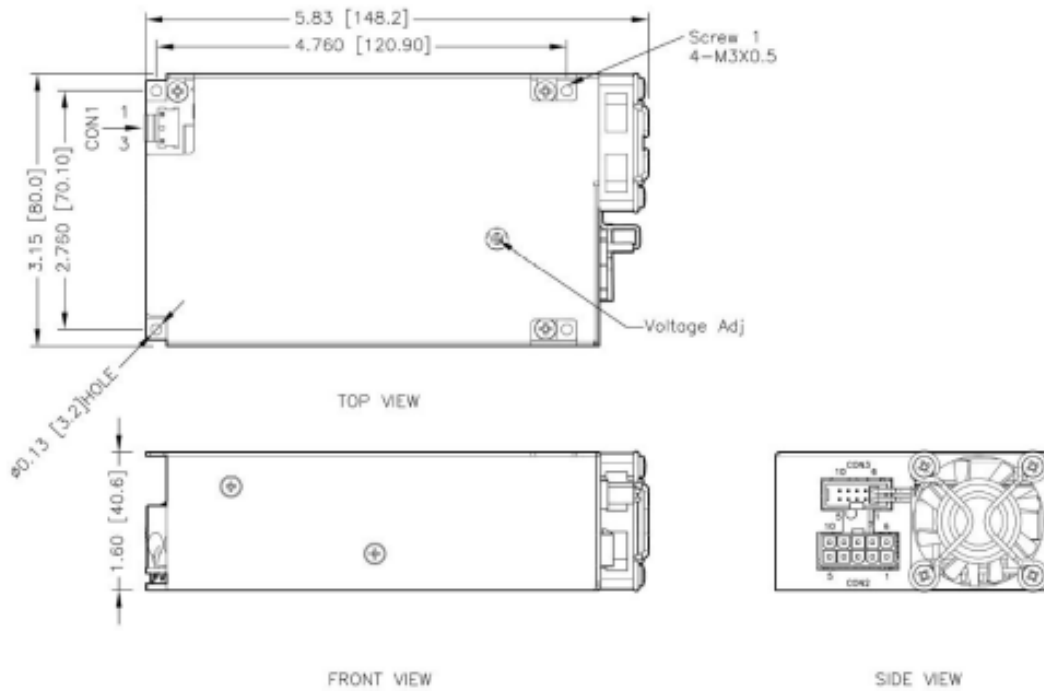

*Either one of four screw holes can be considered as PE connection for CLASS I application.

1. All dimensions in inch [mm]
2. Tolerance : x.xx±0.02 [x.x±0.5]
x.xxx±0.01 [x.xx±0.25]
3. Screw 1 locked torque : MAX 5.2Kgf-cm/0.51N.m

AC – DC

CON1-Input Connector		CON2-Output Connector		CON3 – Aux Connector			
Pin 1	Line	Pin 1,2,3,4,5	+Vout	Pin 1	+Fan	Pin 6	-Fan (GND)
Pin 3	Neutral	Pin 6,7,8,9,10	-Vout	Pin 2	+V Sense	Pin 7	-V Sense
				Pin 3	+Control	Pin 8	-Control (GND)
				Pin 4	+PG	Pin 9	No Pin
				Pin 5	+Standby	Pin10	-Standby (GND)

Mates with:

Molex housing:
09-50-8031

Molex crimp terminals:
2478,6838,45570

Mates with:

Molex housing:
39-01-2105

Molex crimp terminals:
5556,45750

Mates with:

Molex housing: 90143-0008

Molex crimp terminals: 90119

Optional Parts

7N-0265-F :

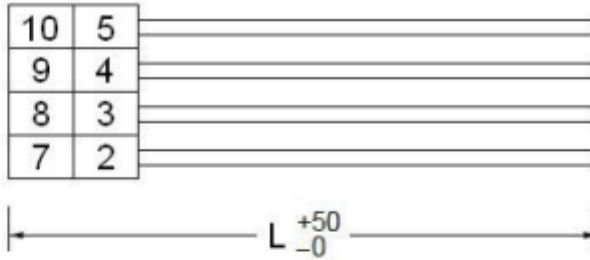

7N-0266-F :

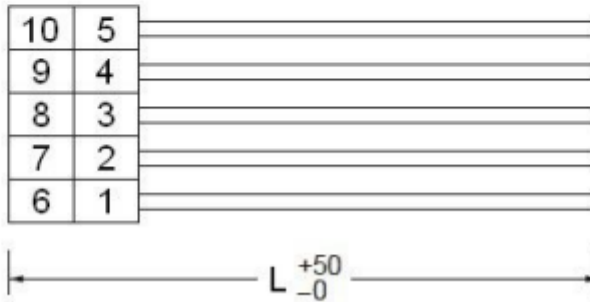

AC – DC

CON3 housing				CON3 housing			
Pin 2	+V Sense	gray	26AWG	Pin 1	+Fan	yellow	26AWG
Pin 3	+Control	orange	26AWG	Pin 2	+V Sense	gray	26AWG
Pin 4	+PG	blue	26AWG	Pin 3	+Control	orange	26AWG
Pin 5	+Standby	red	22AWG	Pin 4	+PG	blue	26AWG
Pin 7	-V Sense	green	26AWG	Pin 5	+Standby	red	22AWG
Pin 8	-Control (GND)	brown	26AWG	Pin 6	-Fan (GND)	brown	26AWG
Pin 9	No wire	---	---	Pin 7	-V Sense	green	26AWG
Pin10	-Standby (GND)	black	22AWG	Pin 8	-Control (GND)	brown	26AWG
				Pin 9	No wire	---	---
				Pin10	-Standby (GND)	black	22AWG

Length (L) : 500mm typical